

Model BT-1201

BTech's Model BT-1201 transducer is an ideal solution for high frequency underwater acoustic communication (AComms).

Specifications (Nominal):

- Resonance Frequency (f_r): 110 kHz
- Coupling Coefficient (k_{eff}): 0.33
- TVR at f_r : 137 dB re 1 $\mu\text{Pa}/\text{V}$
- SPL (max) at f_r (@ 1 m): 177 dB re 1 μPa
- OCVS at f_r : -207 dB re 1 $\text{V}/\mu\text{Pa}$
- Horizontal Beam Pattern: Omnidirectional
- Vertical Beam Pattern: Near-omni (see plot)
- Depth (max): 100 m
- Voltage (max): 100 V_{rms}
- Weight (in air, in water): 4 g (a), 1.3 g (w)

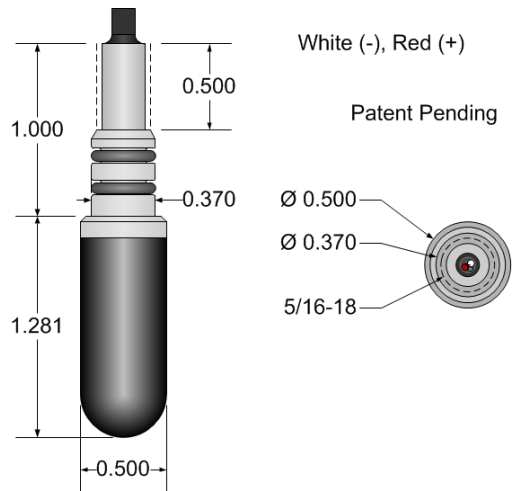

Performance Curves (Nominal):

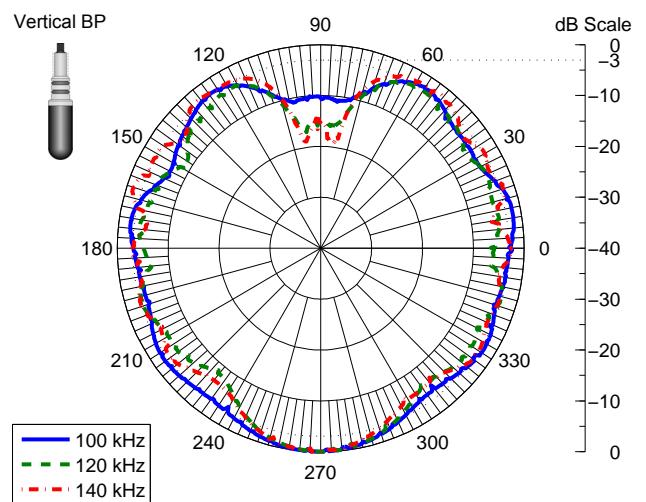
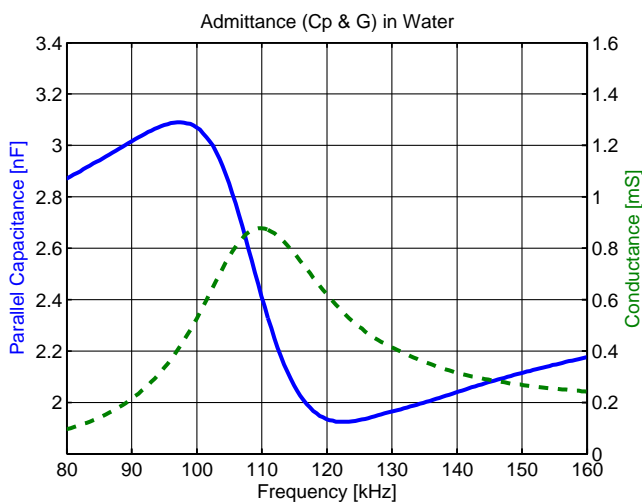
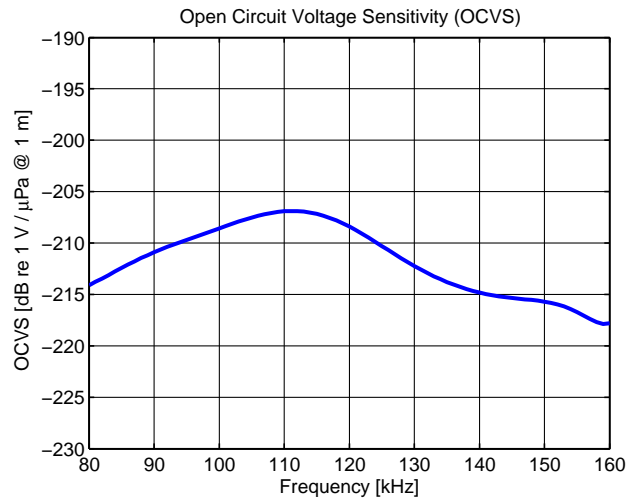
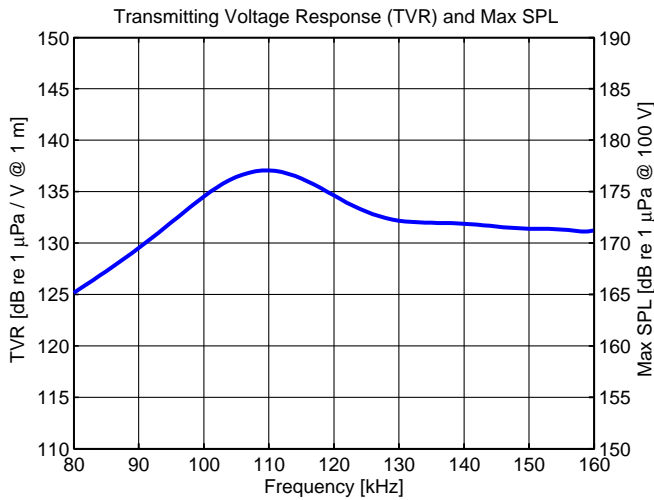

Tuned Performance Curves (Nominal):

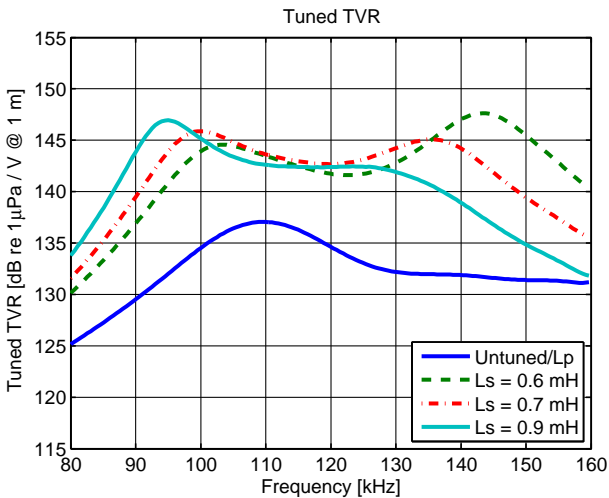
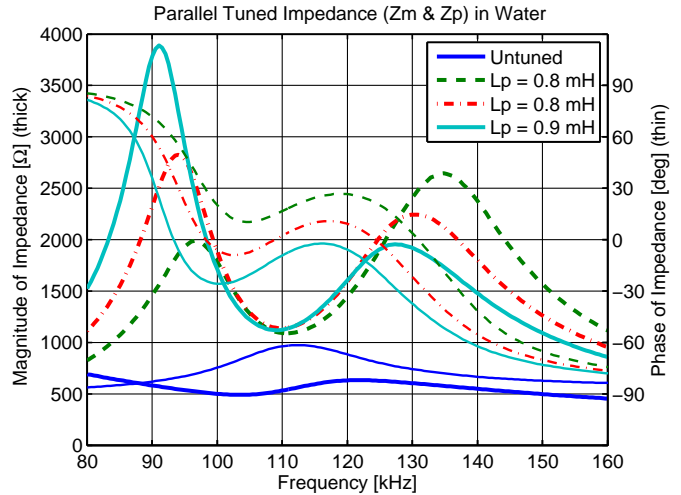
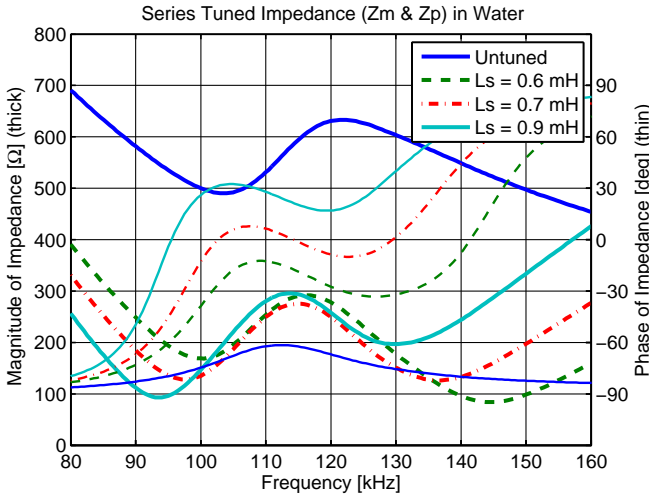
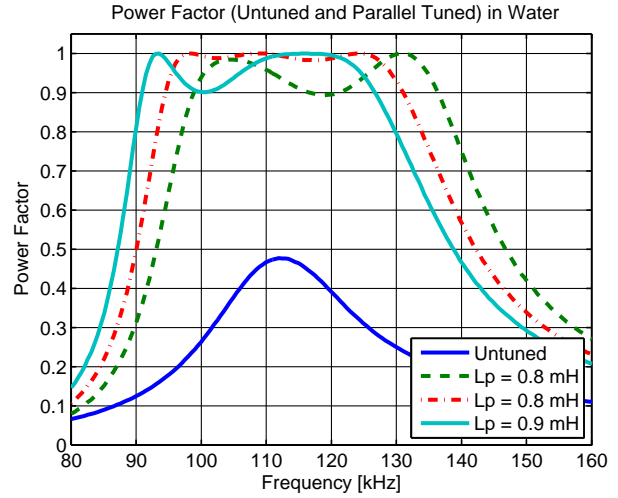
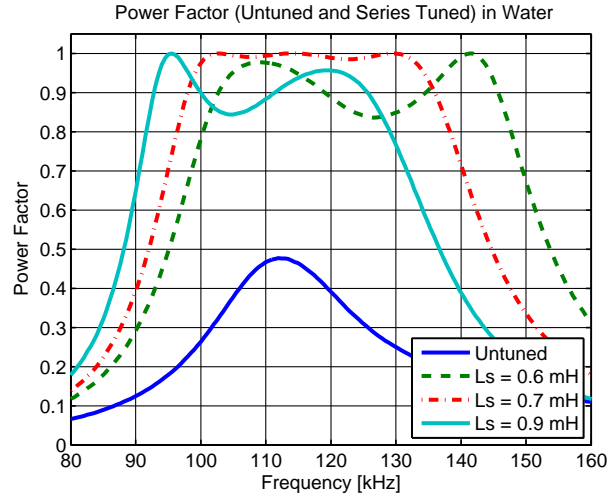

Tuning and Matching is required for highly effective power delivery to the transducer. The impact on system performance for several values of series and parallel inductive tuning elements are provided. BTech also offers a transmit/receive board (TR1) that interfaces with a DSP or benchtop equipment.

BTech has extensive modeling capabilities to optimize any system configuration for greater bandwidth and efficiency.

Contact us for customizable features, such as connector style, increased depth rating, and more...